

Waco & C^o®

contemporary fireplaces





Door de eeuwen heen brengt vuur de mensen samen. Het geeft warmte, licht, bescherming en ... hoop.
Ook in de moderne huiskamer treft men vuur aan, niet enkel in de woonkamer maar ook in de keuken, de werkkamer en zelfs de slaapkamer en op het terras of in de tuin.

Waco & C° biedt u een compleet gamma aan van gas- en houthaarden met bijhorende mantels en kaders. Alle toestellen en kaders zijn ontworpen vanuit één uitgangspunt: sobere en tijdloze lijn.

A travers les siècles, le feu a de tout temps réuni les hommes. Il procure chaleur, lumière, protection ... et espoir.
Le feu est également présent dans les maisons modernes, non seulement au séjour, mais aussi à la cuisine, au cabinet de travail et même dans la chambre, sur la terrasse ou dans le jardin.

Waco & C° vous propose une gamme complète de foyers à gaz et à bois avec manteaux et cadres assortis. Tous les appareils et les cadres ont été conçus dans la même optique : une ligne sobre et intemporelle.

Through the ages fire has always brought people together. It gives warmth, light, protection, ... and hope.
Even in modern houses one comes across fire, not only in the living room, but also in the kitchen, the study and even in the bedroom, on the terrace or in the garden.

Waco & C° offers you a complete range of gas and wood fires with the accompanying mantles and frames. All appliances and frames are designed on the basis of one principle: plain and timeless line.

Nel corso dei secoli il fuoco ha unito le persone. Offre calore, luce, protezione ... e speranza.
Il fuoco si ritrova anche nella casa dei nostri giorni: non solo in soggiorno, ma anche in cucina, nello studio e persino in camera da letto, in terrazzo o in giardino.

Waco & C° vi offre una gamma completa di camini a gas, a legna con rivestimenti e cornici assortiti. Tutti gli apparecchi e le cornici sono stati disegnati con un unico scopo: quello di creare una linea sobria e sempre attuale.

Inhoudstafel

Open gashaarden L I N E ™	2
Open gashaarden Allegro - Vivace	12
Gesloten gashaarden WOW! ™	14
Gesloten gashaard Jazz	21
Mantels en lijsten	24
Open houthaarden L I N E ™	30

Table de matières

Foyers ouverts au gaz L I N E ™	2
Foyers ouverts au gaz Allegro - Vivace	12
Foyers fermés WOW! ™	14
Foyer fermé Jazz	21
Manteaux et cadres pour foyers au gaz.....	24
Foyers ouverts au bois L I N E ™	30

Contence

Open gas-fires L I N E ™	2
Open gas-fires Allegro - Vivace	12
Closed gasfires WOW! ™	14
Closed gasfire Jazz	21
Mantles and ledges for gas-fires	24
Open wood-fires L I N E ™	30

Indice

Focolari aperti a gas L I N E ™	2
Focolari aperti a gas Allegro - Vivace	12
Focolari a gas chiusi WOW! ™	14
Focolari a gas chiusi Jazz	21
Rivestimenti e cornici per camini a gas	24
Focolari aperti a legna L I N E ™	30



Open gashaarden / Foyers à gaz ouverts / Open gas fires / Focolari aperti a gas

De sobere, tijdloze **L I N E**™ open gashaarden zijn verkrijgbaar in breedtes van 80 tot 250 cm.

Voor elk van deze breedtes heeft U zelfs de keuze voor één of beide zijkanten open !

Het mooie vlammenspel komt in de zwarte binnenbekleding, gevuld met basalt-of carrarasteentjes, volledig tot zijn recht. De rugwand kan naar keuze verrijkt worden met een geribd of natuursteen 'rots' patroon.

Het gasvuur, op aardgas of propaan, is uitgerust met een radiografische afstandsbediening met 2 functies : aan-uit en vlammen hoog of laag. Een druk op de knop volstaat !

Voor het gastoestel zijn verder nodig : een aangepast rookkanaal, toevoer van verse lucht, toevoer van gas en elektrische stroom.

Alle modellen zijn CE gekeurd.

Les foyers à gaz ouverts **L I N E**™ sobres et intemporels sont disponibles en largeurs de 80 à 250 cm. Pour chaque largeur, vous avez même le choix entre un ou deux côtés ouverts !

Le beau jeu des flammes est parfaitement mis en valeur dans le revêtement intérieur noir, rempli de gravier basalt ou de galets de Carrara. La face dorsale peut être habillée avec une déco en rainures fines ou aspect 'rocher'. Le foyer à gaz, au gaz naturel ou au propane, est équipé d'une télécommande radiographique qui a 2 fonctions : marche/arrêt et flammes hautes ou basses. Il suffit d'appuyer sur un bouton !

Pour l'appareil à gaz, il faut en outre : un conduit de fumée adéquat, une amenée d'air frais, une amenée de gaz et le courant électrique.

Tous les modèles sont agréés CE.



XL250GLR



L180G

The plain and timeless **L I N E**[™] open gas fires are available in widths from 80 to 250 cm. For each of these widths, you even have the choice of leaving one or both of the sides open!

The attractive, dancing flames show up well against the black lining, filled with basalt or Carrara stones. On the backside of the fireplace, a ribbled or 'rock' looking decoration can be added.

The gas fire (natural or propane gas) is fitted with a radiographic remote control with 2 functions: on/off and high flame/low flame. You simply press a button!

For the gas appliance, you also need an adapted flue, a supply of fresh air, a gas supply, and electricity.

All models are CE approved.

I camini a gas aperti **L I N E**[™] dalla linea sobria e sempre attuale, sono disponibili in diverse larghezze che variano da 80 a 250 cm. Per ognuna di queste larghezze è possibile scegliere di avere uno o tutti e due i lati aperti!

Il suggestivo gioco di fiamme è valorizzato al meglio dal rivestimento interno nero, che può essere rivestito con ciottoli in pietra Basalto o ghiaia Carrara. Il camino a gas (metano o GPL) è dotato di un telecomando a due funzioni: una per l'accensione e lo spegnimento del camino e l'altra per la regolazione delle fiamme (alte o basse). Non dovete far altro che premere un pulsante!

Per il funzionamento del caminetto a gas sono necessari una canna fumaria adeguata, una presa d'aria esterna, l'allacciamento al gas e la corrente elettrica.

Tutti i modelli sono dotati di marchio CE.



L180GL





XL250GLR



L150G



XL250GLR + NIRVANA



Technische gegevens - Fiche technique - Technical data - Schede tecniche  pdf/dwg: www.wacoandco.be

Standard: front model / modèle frontal / modello monofacciale

*	L80G L80P	L100G L100P	L120G L120P	L150G L150P	L180G L180P	L200G L200P	L200GS L200PS	L220G L220P	L220GS L220PS	L250G L250P	L250GS L250PS	XL250G XL250P
A	800	1000	1200	1500	1800	2000	2000	2200	2200	2500	2500	2500
B	400	400	400	400	400	400	400	400	400	400	400	400
C	800	800	1000	1200	1500	1800	1500	2000	1500	2200	1500	2500
D	590	590	590	790	1040	1040	1040	1040	1040	1040	1040	1040
E **	200	200	250	250	300	300	300	300	300	300	300	350
F	500	500	500	500	500	500	500	500	500	500	500	500
G***	310	310	310	310	310	310	310	310	310	310	310	310
H****	150	150	200	200	2 x200	2x200	2 x200	2 x200	2 x200	2 x200	2 x200	2 x250
I	945	1145	1345	1645	1945	2145	2145	2345	2345	2645	2645	2645

* G: gas / gaz de ville / natural gas / gas metano
P: propaan /gaz propane /propane /GPL

** Hoogte rookkanaal / hauteur conduit /hight chimney / altezza canna fumaria: min. 6m!
1 zijde open (L of R) / 1 côte ouvert (G ou D) / 1 side open (L or R) / 1 lato aperto (DX o SX): +50mm
2 zijden open(L en R) / 2 côtes ouverts(G et D) / 2 sides open (L and R) / 2 lati aperti (DX e SX): +100mm

*** Min. hoogte /hauteur min. /min. hight /altezza min.: 220mm

**** toevoer verse lucht / arrivée d'air frais /arrival fresh air / presa d'aria esterna

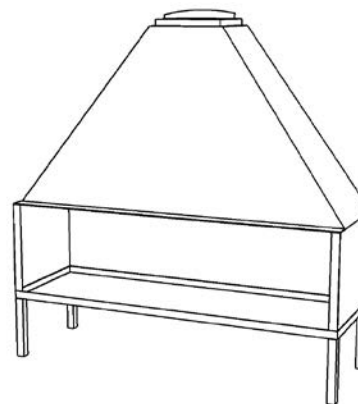
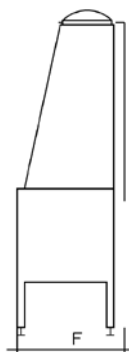
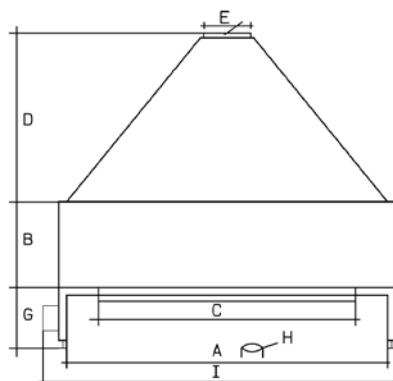

Opties – Options – Optional – Optional

- 1 zijde open (LofR) / 1 côté ouvert (GouD) / 1 side open (LorR) / 1 lato aperto (DXoSX): standard code +L
rookkanaal / conduit / chimney / canna fumaria: diam. standard 'E' + 50 mm



standard code + L



standard code + R

- Model Panorama
2 zijden open (LenR) / 2 côtés ouverts (GetD) / 2 sides open (LandR) / 2 lati aperti (DXeSX): standard code +LR
rookkanaal / conduit / chimney / canna fumaria: diam. standard 'E' + 100 mm
geen klep / pas de clapet / no valve / senza valvola!



standard code + LR

- Model Tunnel
achterwand glas / partie arrière vitrée / back side glass / parte posteriore vetrata



Carrara



Basalt(o) Split



Opbouw - Montage - Construction - Struttura

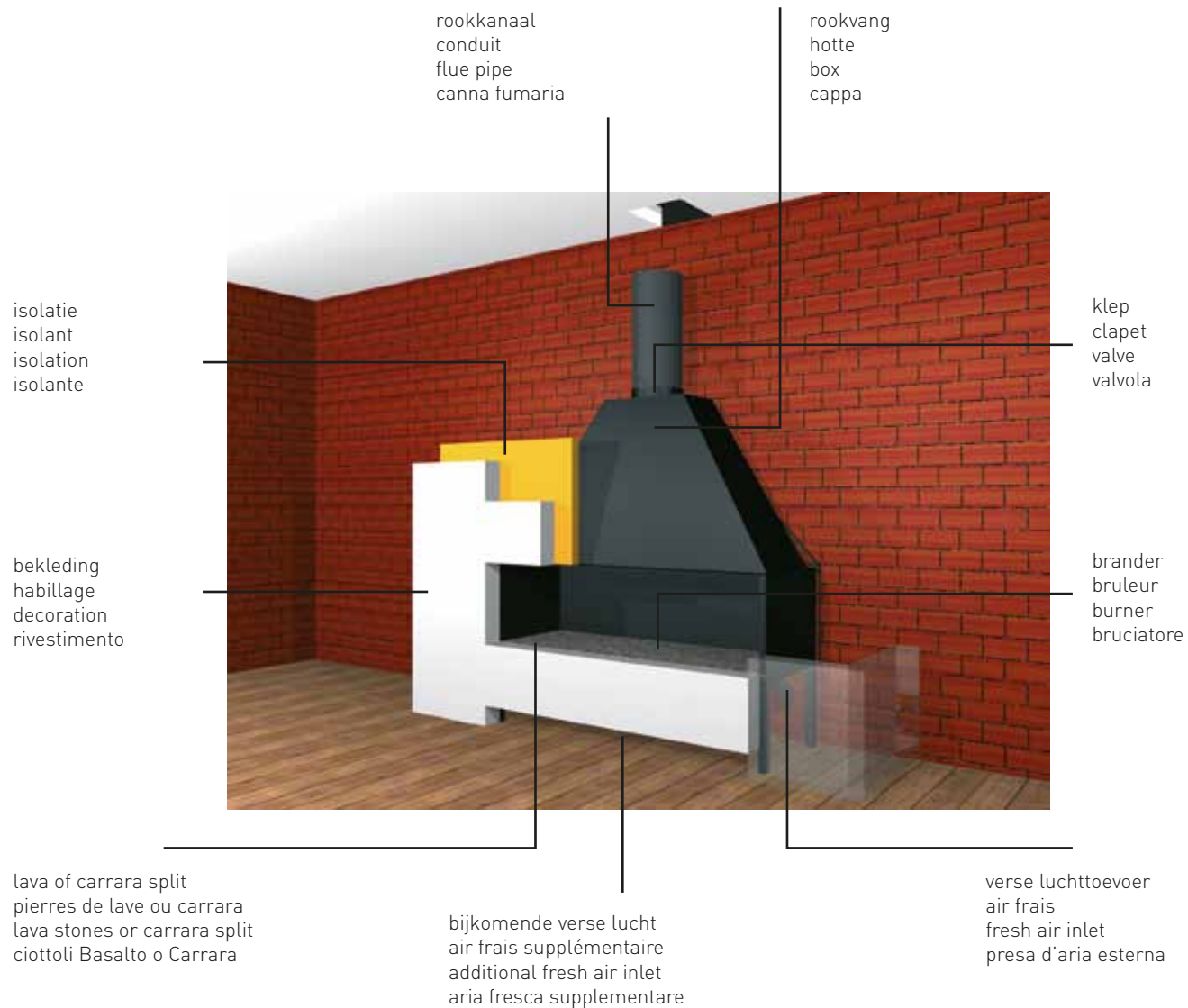



L120G

Technische gegevens - Fiche technique - Technical data - Scheda tecnica  pdf/dwg: www.wacoandco.be

Allegro

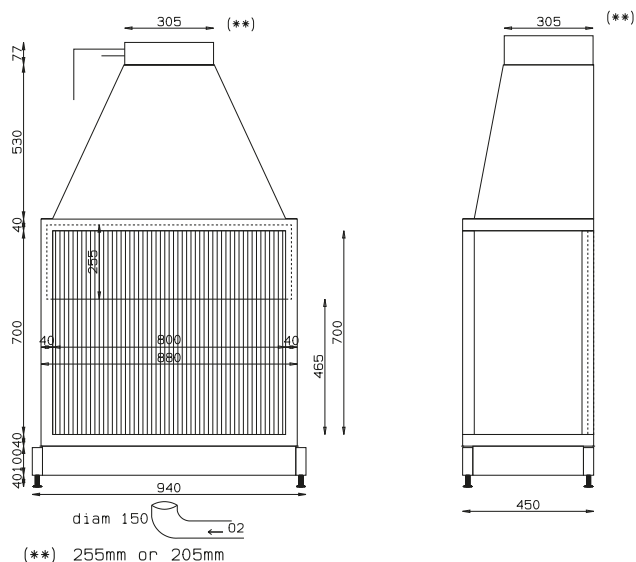

Vivace

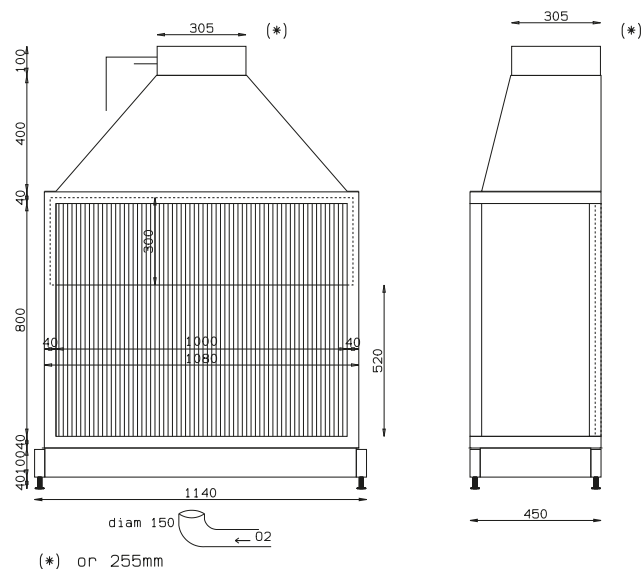

G: gas / gaz de ville / natural gas / gas metano

P: propaan /gaz propane /propane /GPL

Hoogte rookkanaal / hauteur conduit /high chimney / altezza canna fumaria: min. 6m!

Min. hoogte /hauteur min. /min. hight /altezza min.: 220mm

toevoer verse lucht / arrivée d'air frais /arrival fresh air / presa d'aria esterna

VIVACE



Gesloten gashaarden / Foyers au gaz fermés / Closed gasfires / Camini a gas chiusi

De gesloten **WOW!**[™] gashaarden zijn rasechte rendementshaarden. De gasbrander wordt ingebouwd in een gesloten verbrandingskamer. Deze is omgeven door een convector. Via 2 of 4 slangen wordt de opgewarmde lucht in de convector afgevoerd naar de huiskamer.

De haard heeft een 'gesloten verbranding', wat betekent dat de haard volledig autonoom funktioneert in de ruimte waarin hij zich bevindt. Het concentrisch rookkanaal zorgt voor de afvoer van de verbrandingsgassen én de aanvoer van verse lucht. Afzonderlijke toevoer van verse lucht is dus niet nodig.

De haard is afstandsbediend en is verkrijgbaar in 3 breedtes: 100 cm, 120 cm en 150 cm. De binnenbekleding kan met basalt- of carrarasteentjes, met of zonder keramische stammenset.

Alle modellen zijn CE gekeurd.

The closed **WOW!**[™] gas fires are full-blown efficiency fires. The gas burner is built into a closed combustion chamber which is enclosed by a convector. The heated air in the convector is channelled into the living room through 2 or 4 hoses.

The fire has a 'closed combustion' system. This means that the fire operates with complete autonomy in the room in which it is located. The concentric flue provides both the discharge of the combustion gases and the supply of fresh air. A separate supply of fresh air is not necessary.

The fire is operated by remote control and available in 3 widths: 100 cm, 120 cm and 150 cm. The lining is available with basalt or Carrara stones, with or without a ceramic trunk set.

All models are CE approved.

Les foyers à gaz fermés **WOW!**[™] sont de vrais foyers à rendement. Le brûleur à gaz est encastré dans une chambre de combustion fermée. Celle-ci est entourée d'un convecteur. L'air réchauffé dans le convecteur est transporté au séjour au moyen de 2 ou 4 tuyaux.

Le foyer a une 'combustion fermée', ce qui signifie que le foyer fonctionne de façon entièrement autonome dans l'espace où il se trouve. Le conduit de fumée de type concentrique (double paroi) sert à l'évacuation des gaz de combustion ainsi qu'à l'amenée d'air frais. Une amenée séparée d'air frais n'est donc pas nécessaire.

Le foyer se commande à distance et est disponible en 3 largeurs : 100 cm, 120 cm et 150 cm. Le revêtement intérieur est disponible avec le gravier du basalt ou des galets de Carrara, avec ou sans kit bûches en céramique. Tous les modèles sont agréés CE.

I modelli a gas chiusi **WOW!**[™] sono dei veri caminetti. Il bruciatore a gas è incastonato in una camera di combustione chiusa, rivestita da un mantello convettivo. L'aria riscaldata può essere convogliata in una o più stanze tramite 2 o 4 collegamenti. I camini hanno una combustione a "circuito chiuso"; funzionano quindi in maniera del tutto autonoma all'interno dell'ambiente.

La canna fumaria coassiale consente la fuoriuscita del gas di combustione e l'apporto dell'aria comburente.

I camini si comandano a distanza e sono disponibili in 3 diverse larghezze: 100, 120 e 150 cm. La base della camera di combustione può essere rivestita in ciottoli in pietra Basalto o ghiaia Carrara, con o senza tronchetti ceramici.

Tutti i modelli sono dotati del marchio CE.



W120G

Technische gegevens - Fiche technique - Technical data - Scheda tecnica  pdf/dwg: www.wacoandco.be

*	W100G	W120G W120P***	W150G
In mm			
A	1185	1385	1685
B	772	772	772
C	90à140	90à140	90à140
D	410	410	410
E	167	167	167
F	200	200	200
G	1072	1272	1572
H	1060x400	1260x400	1560x400
I	60	60	60
J**	145	145	145
K	100/150	100/150 130/200	100/150 130/200
L	345	345	345
Nom charge	7,94Kw	9,16Kw	10,7Kw
Cons.	0,84m³/h	0,97m³/h	1,14m³/h



* G: aardgas / gaz de ville / natural gas / gas metano

** J: W100G - W120G: 2 uitlaten / 2 sortis / 2 outlets / 2 uscite aria

*** P: propaan / gaz propane / propane / GPL

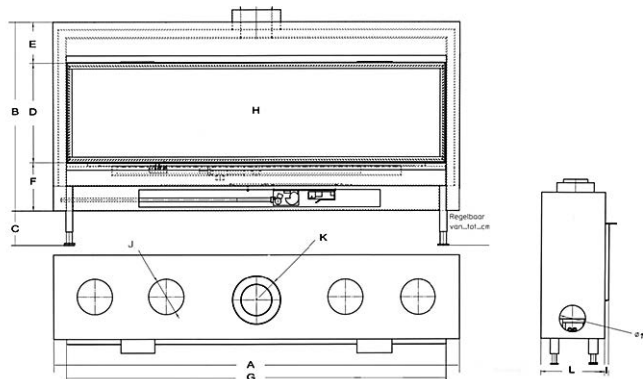

Rendement: max 85%
 Eff class: (n)=2
 Electr.: 230VAC/~ 6V
 CE: EN613

Opties - Options - Optional - Optional

-



Carrara



Basalt(o) Split



Stammenset / Kit bûches / Log-set / Tronchetti ceramici



- Model tunnel / Double face / Bifacciale

Standard code + T



W150GT



W150G



W150G

Opbouw - Montage - Construction - Struttura

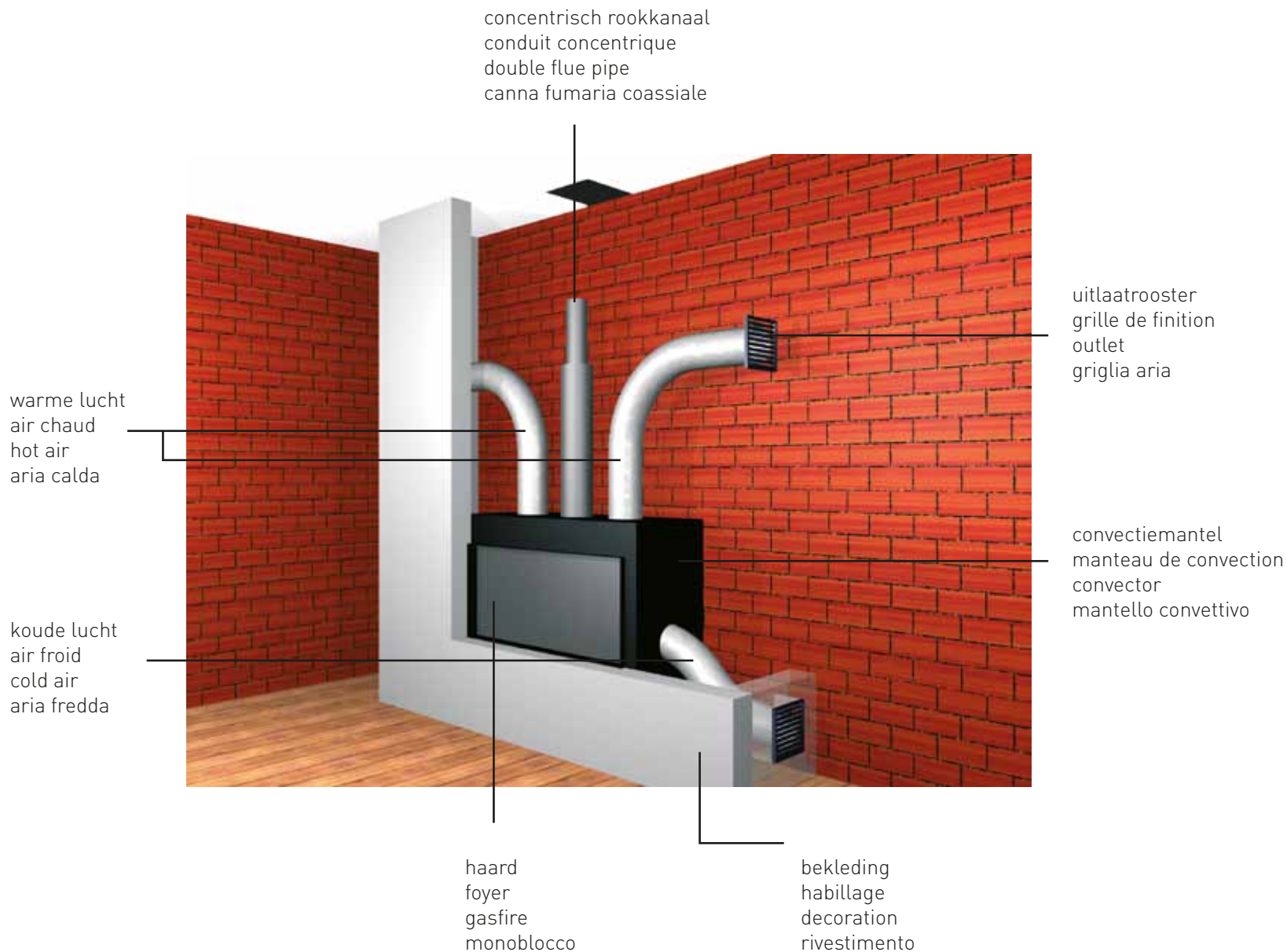

Jazz Gesloten gashaard / Foyer à gaz fermé / Closed gas fire / Camini a gas chiusi

Technische gegevens - Fiche technique - Technical data - Schede tecnica  pdf/dwg: www.wacoandco.be

Jazz

G: gas / gaz de ville / natural gas / gas metano P: propaan /gaz propane /propane /GPL

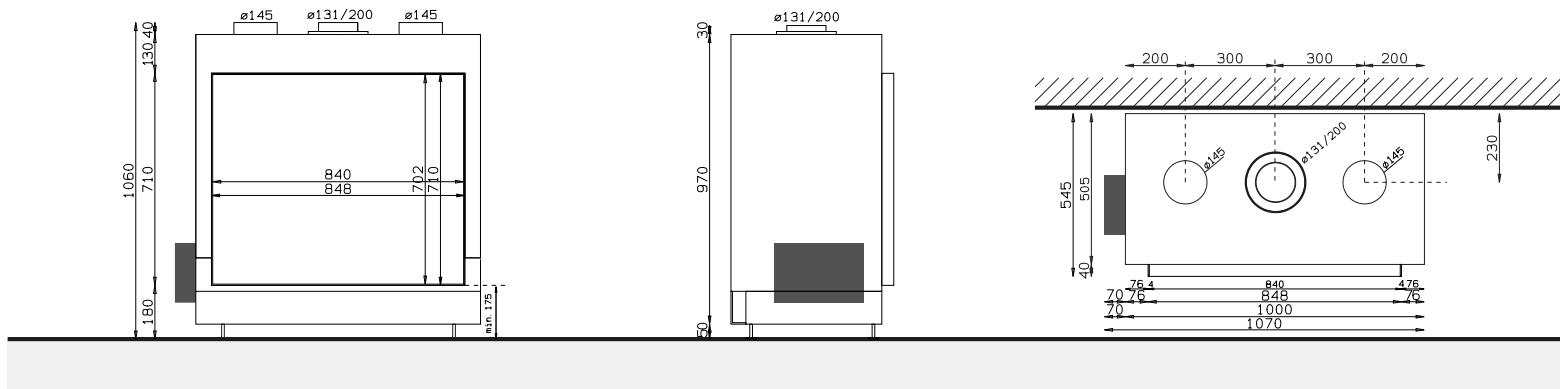

Rookkanalen - Conduits - Chimney flue pipes - Canna fumaria

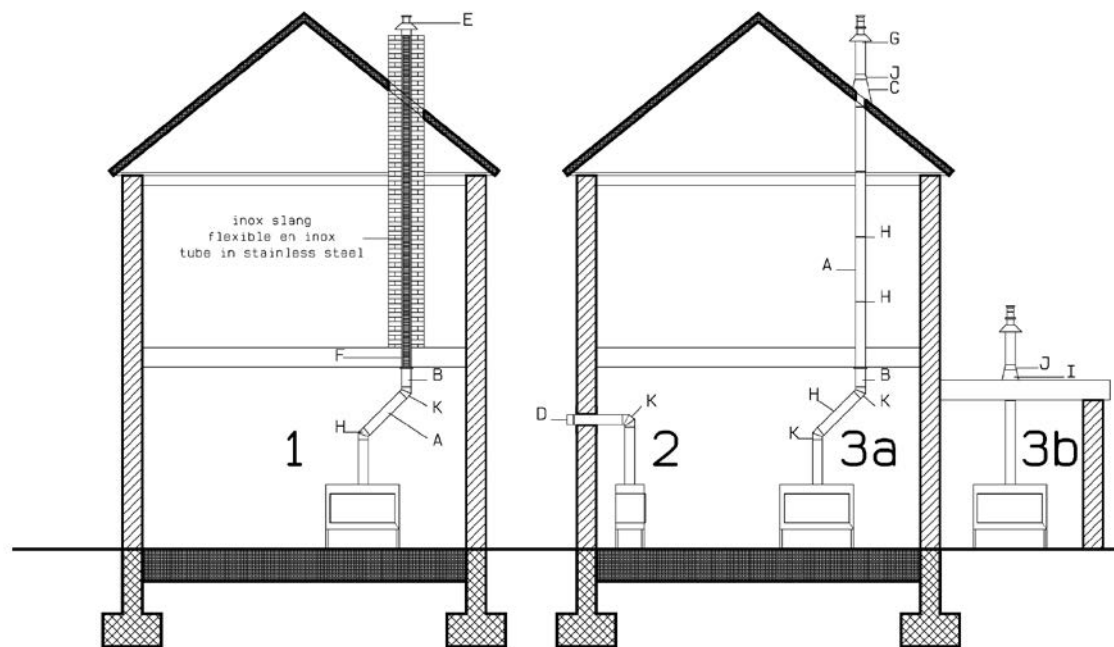

CONFIGURATIES / CONFIGURATIONS / CONFIGURAZIONE / CONFIGURAZIONE

- 1 Aansluiting op bestaande schouw
- 2 Muurdoorvoer
- 3a/3b Dakdoorvoer

- 1 Connection with existing flue pipe
- 2 Horizontal terminal
- 3a/3b Vertical terminal (roof)

- 1 Accordage conduit existant
- 2 Sortie façade
- 3a/3b Sortie verticale (toiture)

- 1 Allacciamento a canna fumaria esistente
- 2 Uscita a parete
- 3a/3b Uscita soffitto

A Recht element / Elément droit / Length / Elemento diritto / Tubo diritto (25cm / 50cm / 100cm)



B Regelbaar element / Longueur ajustable / Adjustable length / Tubo telescopico / Elemento regulável



C Slab plat dak / Solin de toit plat / Flat roof flashing / Conversa piana / Rufo telhado
Slabpan / Incline pente / Slope roof flashing / Conversa inclinata / Telha de avental (20°-30° /25°-45°)



D Geveldoorvoer / Sortie façade / Horizontal terminal / Uscita a parete / Saída mural



E Schoorsteendoorvoer / Sortie vertical / Flue opening / Comignolo / Chapeu de construção



F Schoorsteendoorvoerkit / Kit d'assainissement / Kit flue opening / Kit adattatore canna esistente / Kit de conduita de chaminé

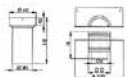

G Dakdoorvoerkit / Sortie verticale / Vertical terminal / Comignolo antivento / Kit de conduita de tecto



H Muurbeugel / Bride murale / Wall band / Staffa a muro / Abraçadeira parede



I Centreerplaat / Plaque de centrage / Adjustable roof plate / Flangia / Base de centragem



J Stormkraag / Larmier / Storm Collar / Copertina conversa / Gola



K Bocht / Coude / Elbow / Curva / Curva (15° /30° /45° /90°)



Mantels en Lijsten voor Gashaarden / Manteaux et Cadres pour les foyers aux gaz / Mantles and ledges for gas fires / Rivestimenti e cornici per camini a gas

Voor wie een kant en klare afwerking wil rond de haard, ontwierp **Waco & C^o** een aantal standaard design mantels voor de verschillende gashaarden. De design staalkaders zijn verkrijgbaar in verschillende uitvoeringen : blauw(*) gewalst, mat zwart gelakt en geroest. De afmetingen en manier van bevestigen vindt U in de tabellen

(*) Bij blauw gewalst zijn de puntlassen zichtbaar. De typisch blauwe 'vlam' in de plaat is niet constant maar varieert van plaat tot plaat.

Pour les personnes qui souhaitent une finition toute faite autour de la cheminée, **Waco & C^o** a conçu quelques manteaux design standard pour les différents foyers à bois et à gaz. Les cadres design en acier sont disponibles en différentes finitions : bleu (*) laminé, noir mat laqué et rouillé. Vous trouverez les dimensions et la méthode de fixation dans les tableaux.

(*) Pour le modèle en bleu laminé, les points de soudure sont visibles. La 'flamme' bleue typique dans la plaque n'est pas constante, mais est différente sur chaque plaque.

For anyone wanting a ready-made finish around the fire, **Waco & C^o** has developed a number of standard design mantles for the various wood and gas fires. The design steel frames are available in different finishes: rolled blue(*), painted matt black and rusted. The charts show the dimensions and method of installation.

(*) With rolled blue, the spot welding is visible. The typical blue 'flame' in the plate is not constant, but varies from plate to plate.

Per coloro che desiderano una rifinitura già pronta tutto intorno al camino, **Waco & C^o** ha realizzato alcuni rivestimenti ornamentali di serie per i vari tipi di camini a legna e a gas. Le cornici ornamentali in acciaio sono disponibili in varie lavorazioni: blu (*) laminato, nero opaco laccato e ruggine. Nelle tabelle troverete indicate le dimensioni e il metodo di fissaggio.

(*) Con il blu laminato, le saldature per punti sono visibili. La tipica "fiamma" celeste nella piastra non è costante, ma varia da piastra a piastra.



Technische gegevens - Fiche technique - Technical data - Scheda tecnica

TYPE	DHARMA	SHIVA	KARMA	BRAHMAN	NIRVANA
L 80G - L 80P	o	o	•	o	o
L100G - L100P	o	o	•	o	o
L120G - L120P	•	o	o	o	o
L150G - L150P	•	o	o	o	o
L180G - L180P	•	o	o	o	o
L200G - L200P	•	o	o	o	•*
L220G - L220P	o	•	o	o	•*
L250G - L250P	o	•	o	o	•*
XL250G - XL250P	o	o	o	o	•*
W100G - W100P	o	o	•	•	o
W120G - W120P	o	o	•	•	o
W150G - W150P	o	o	•	•	o
W180G - W180P	o	o	•	•	o

* Panorama

Blauw gewalst (BL) / Bleu laminé / Rolled blue / Blu laminato



Mat zwart gelakt (ZW) / Noir mat laqué / Painted matt black / Nero opaco laccato

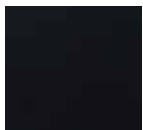

Geroest (RO) / Rouillé / Rusted / Ruggine





DHARMA L120G
DHARMA L120P

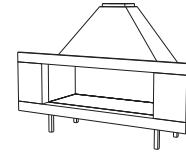
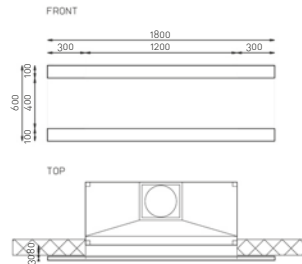

DHARMA L150G
DHARMA L150P

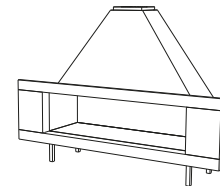
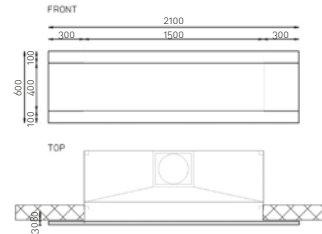

DHARMA L180G
DHARMA L180P

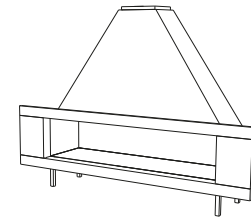
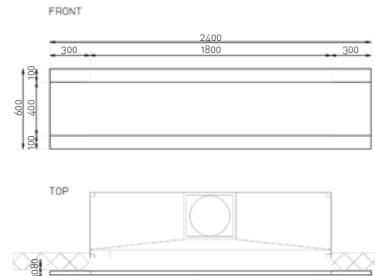

DHARMA L200G
DHARMA L200P

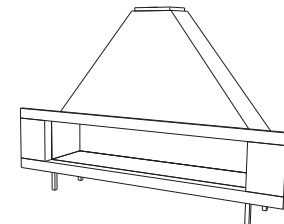
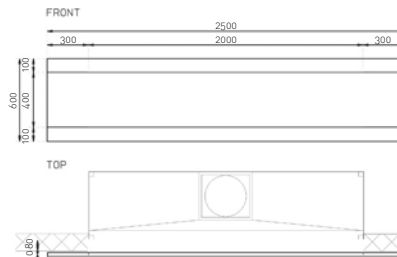



SHIVA L220G
SHIVA L220P

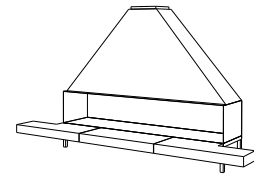
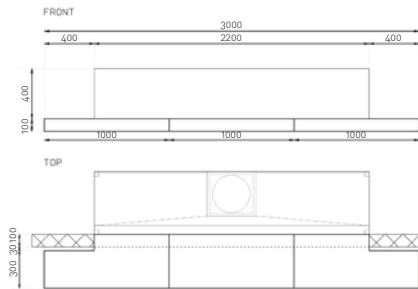

SHIVA L250G
SHIVA L250P

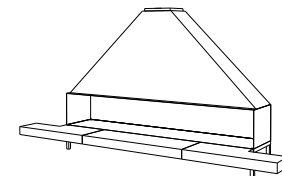
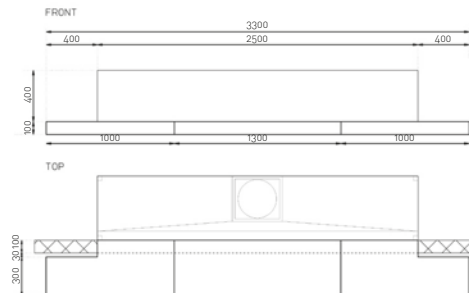

KARMA L80G
KARMA L80P

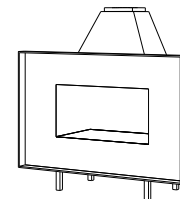
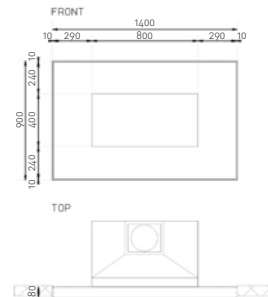

KARMA L100G
KARMA L100P

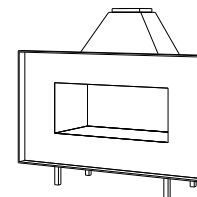
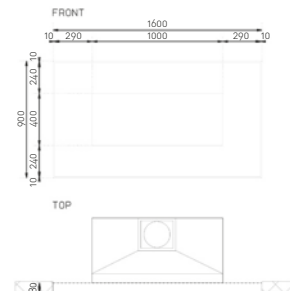



NIRVANA L200G
NIRVANA L200P

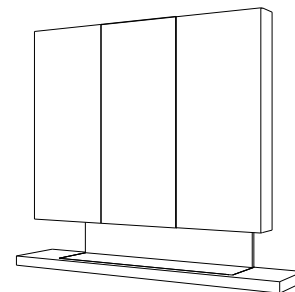
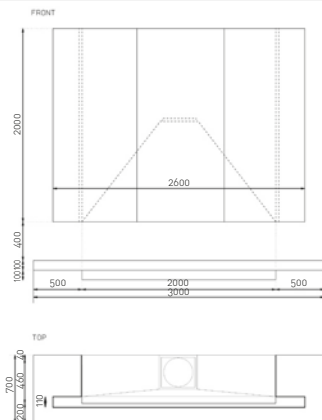

NIRVANA L220G
NIRVANA L220P

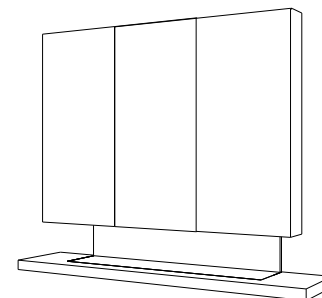
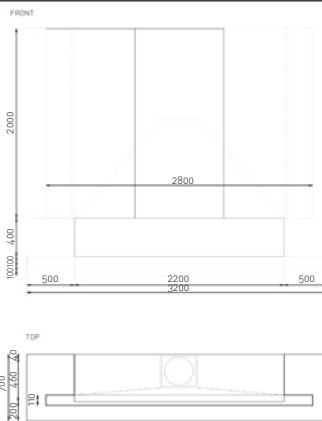

NIRVANA L220G
NIRVANA L220P
NIRVANA XL220G
NIRVANA XL220P

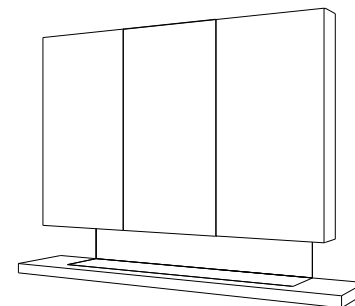
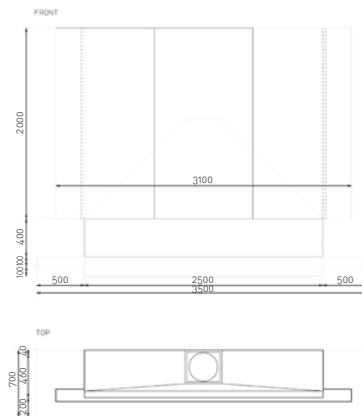

Mantels voor WOW!™ haarden / Cadres pour foyers WOW!™ / Mantles for WOW!™ -gasfires / Rivestimenti e cornici per camini a gas WOW!™

KARMA



	WOW100	WOW120	WOW150
A	1600	1800	2100
B	944	944	944
C	80	80	80
D	10	10	10
E	1070x410	1270x410	1570x410

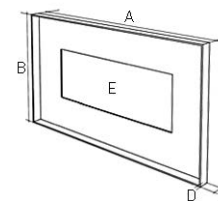

BRAHMAN



	WOW100	WOW120	WOW150
A	1090	1290	1590
B	1320	1420	1610
B1			310
C	80	80	80
D	10	10	10
E	1070x410	1270x410	1570x410

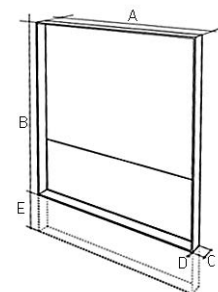

blauw gewalst (BL) / bleu laminé /
rolled blue / blu laminato



mat zwart gelakt (ZW) / noir mat laqué /
painted matt black / nero opaco laccato

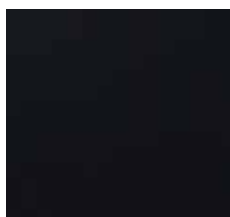

geroest (RO) / rouillé /
rusted / ruggine



Open houthaarden / Foyers à bois ouverts / Open wood fires / Focolari aperti a legna

Open houthaarden **LINE™**

Voor de liefhebber van de échte open houthaard is deze reeks het neusje van de zalm!

Tijdloos, zonder kader, sober en oersterk tegelijk. De binnenbekleding bestaat uit grof of fijn geribde gietijzeren platen. De haard kan verkregen worden met een verzonken asbak en een opschuifbaar vonkenscherm in fijn metaalgaas. Voor wie een hoger rendement wil, is er een warmte-recuperatie kit met of zonder ventilatoren.

De basisreeks is verkrijgbaar in breedtes van 70 tot 150 cm. Daarnaast is alle maatwerk mogelijk!

Voor het goed functioneren van de haard is er een aangepast rookkanaal en toevoer van verse lucht nodig... O, ja, en hout natuurlijk!

Foyer à bois **LINE™**

Cette série est le fin du fin pour les amateurs des véritables cheminées ouvertes !

Intemporel, sans cadre, sobre et en même temps extrêmement solide. Le revêtement intérieur est composé de plaques en fonte nervurées brutes ou fines. Le foyer peut être livré avec un cendrier encastré et un pare-étincelles coulissant en fine toile métallique. Pour un rendement plus élevé, il existe un kit de récupération de chaleur avec ou sans ventilateurs.

La série de base est disponible en largeurs allant de 70 à 150 cm. Tous travaux sur mesure sont en outre possibles !

Pour le bon fonctionnement du foyer, un conduit de fumée approprié et une amenée d'air frais sont nécessaires... ah oui, et du bois évidemment !



L120H50



Wood fire **L N E**[™]

For the real open fireplace enthusiast, this series is the very best!

Timeless, without frame, plain, and highly durable at the same time. The lining consists of sturdy or slender corrugated cast-iron plates. The fireside can be obtained with a sunk ash pan and a sliding spark screen made of wire netting. For anyone wanting greater efficiency, there is a heat recuperation kit with or without ventilators.

The basic series is available in widths from 70 to 150 cm. Furthermore, all sorts of custom-made work are possible!

To ensure that the fire operates properly, you need a specially adapted flue and a supply of fresh air... Oh yes, and wood, of course!

Camini a legna **L N E**[™]

Per gli amanti dei veri camini aperti a legna, questa serie è il top!

Sempre attuale, senza cornice, sobria e al tempo stesso estremamente robusta. Il rivestimento interno è composto da lastre in ghisa a scanalature larghe o fini. Il camino può essere fornito unitamente a un cassetto ceneri incassato e uno schermo parascintille a scomparsa in rete metallica a maglie fini. Per una resa superiore, è anche disponibile un kit di recupero di calore con o senza ventilatori.

La serie di base è disponibile in diverse larghezze variabili da 70 a 150 cm, ma sono realizzabili anche altre dimensioni su richiesta e su misura!

Per il buon funzionamento del camino, sono necessari una canna fumaria adeguata, una presa d'aria esterna....e la legna naturalmente!

Technische gegevens – Fiche technique – Technical data - Scheda tecnica  pdf/dwg: www.wacoandco.be

Standard : front model / modèle frontal / modello monofacciale

	L80H50	L100H50	L120H50	L150H50
A	500	500	500	500
B	800	1000	1200	1500
C	435	435	535	535
D	1180	1180	1280	1280
E *	200	250	250	300
F	870	1070	1270	1570

* hoogte rookkanaal / hauteur conduit / highth chimney / altezza canna fumaria: min. 6m

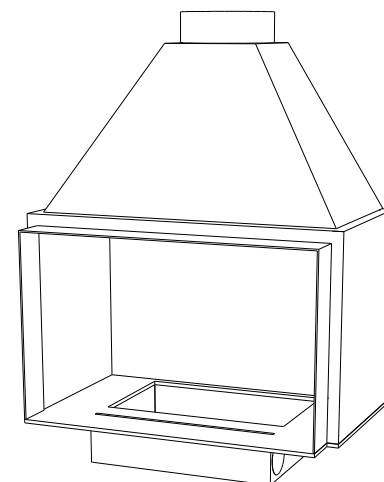
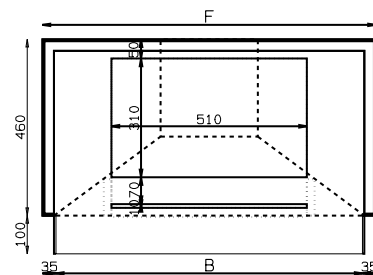
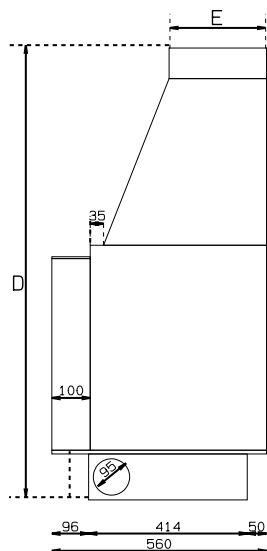
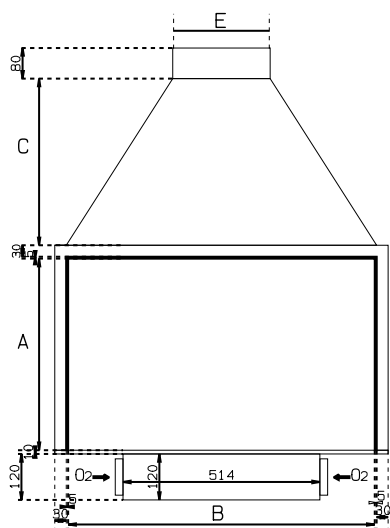

Opties – Options – Optional – Optional

- maatwerk / sur mesures / on measure / su misura
- gietijzer / plaques en fonte / cast-iron panels / piastre in ghisa



fijne rib
rainures fines
finely ribbed
scanalature sottili



grove rib
rainures larges
droughly ribbed
scanalature larghe

vlakke afwerking / finission plane / finitura piana, senza scanalature

- opschuifscherm / parre-feu escamotable /
movable spark catcher / parascintille a scomparsa

	L80H50	L100H50	L120H50	L150H50
A	800	1000	1200	1500
B	500	500	500	500
C	40	40	40	40
D	1200/1450	1200/1450	1200/1450	1200/1450
E	35	35	35	35

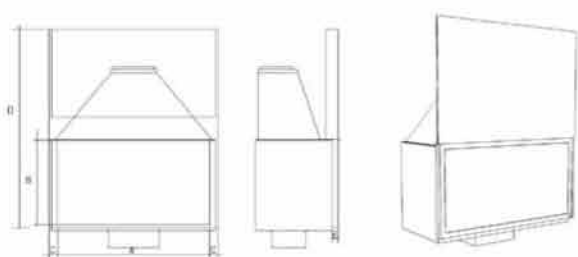



L100H75



L180H70



Opbouw - Montage - Construction - Struttura

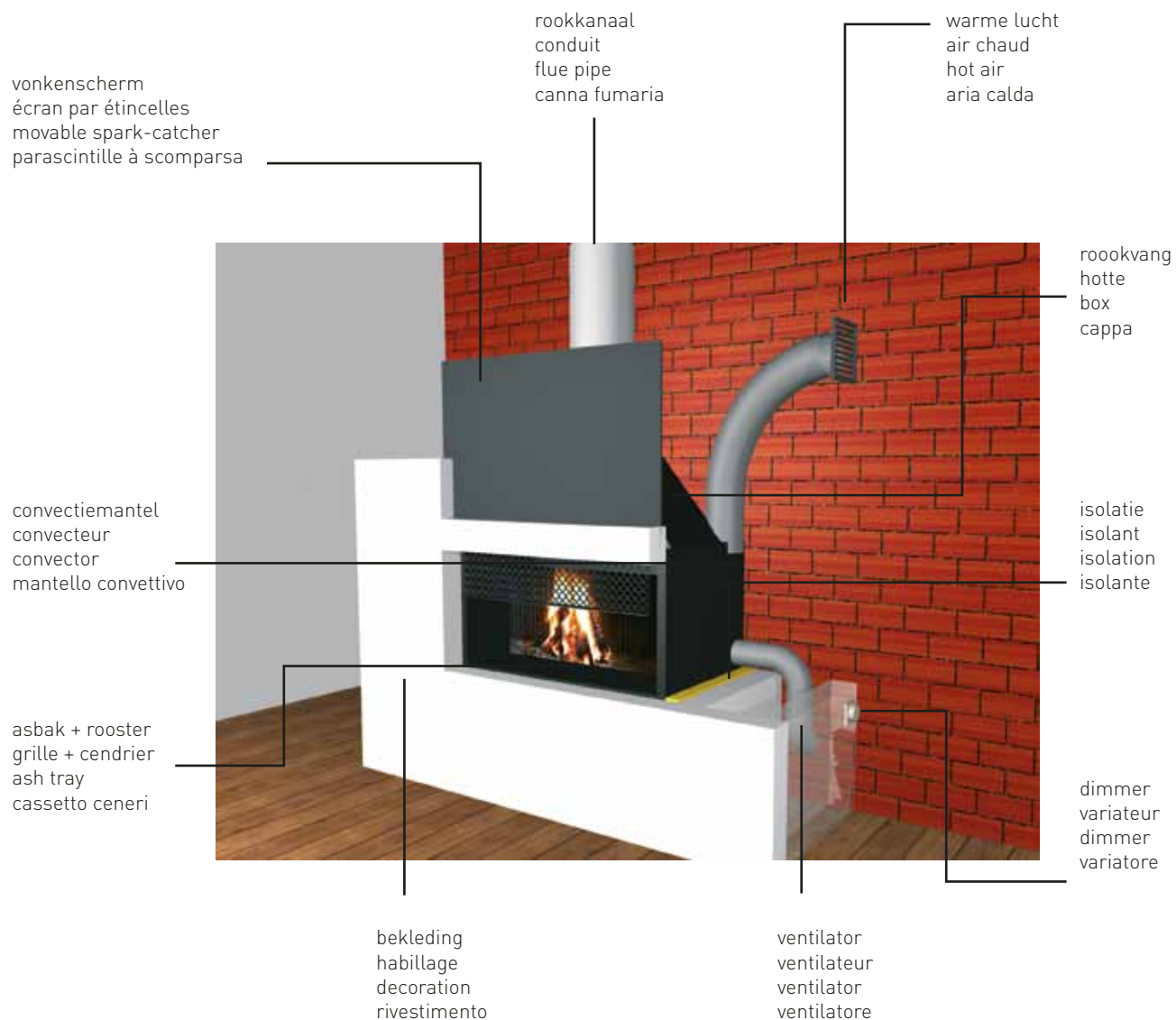



Design and creating company **Waco & C°**, Krommebeekstraat 19, B-8930 Menen,
www.wacoandco.be

Waco & C°, **L I N E™**, **WOW!™** are registered trademarks

Unauthorised copying of models and names is strictly prohibited

Waco & C° has the right to change dimensions, pictures and models on own initiative

Pictures by Jo Pauwels

Courtesy to: ABC Interieur Ltd

M. Boucket int.arch.

Contrast wooninrichters Antwerp

D'Henin-Pauchet int.arch.

J.M. Vynckier int.arch.

M. Vandewiele int.arch.

L. Pratz int.arch.

F. D'Hooghe int.arch.

S. Verducruysse int.arch.

Waco & C^o

p/a ABC Interieur nv
IZ Menen-Oost
Krommebeekstraat 19
B-8930 Menen
Belgium
Tel 0032 56 42 31 66
Fax 0032 56 40 41 86
www.wacoandco.be
info@wacoandco.be

